

SYSTEM CATALOG SHEET

RECA RS



Ground structure system RECA RS-5

Type of system: Two-supported

Installation method: Driven into the ground

Module type: Single-sided with a frame

Material: S390 structural steel

Anti-corrosion coating: Magnelis®

Intended use: Commercial

Inclination angles: 15-35°

Module arrangement: 5 modules horizontally



Wind zones



Snow zones

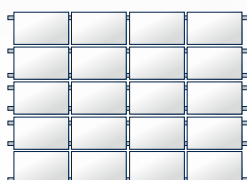

Two-supported



Driven into the ground



Module with frame



Horizontal installation



Varied inclination angles of panels



Guarantee



Magnelis®



Durability and reliability

All of our mounting systems are coated with the innovative Magnelis® coating, which is up to 10 times more corrosion-resistant than typical galvanized steel.



Savings and economy

Optimised project ensures low cost and consumption of construction material and high reliability for many years, which results in a lower price and higher return on investment over the years.



Eco-friendly

The system has been developed and manufactured in accordance with certified sustainability standards. In addition, the components are recyclable and can be easily dismantled.

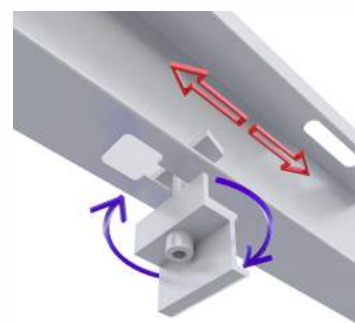

Quick and easy installation

POLISH MANUFACTURER